

# CUSTOM CHOICES Create your own furniture in FABRIC or LEATHER

We make creating furniture in fabric or leather simple. In five easy steps you select your depth, frame, arm, cushion and base styles. Our skilled craftspeople will bring your design to life in short order. How easy is that?

## STEP 1

Choose Your Depth

-----  
Your choice

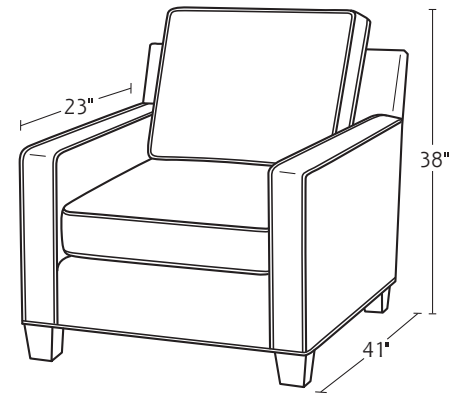
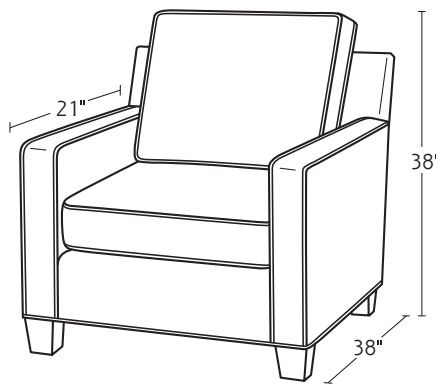
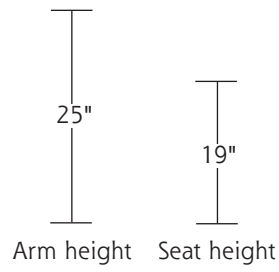

**S** Standard Depth 38"  
**LS** Standard Depth Leather 38"

**M** Plush Depth 41"  
**LM** Plush Depth Leather 41"

## STEP 2

Choose Your Style (See reverse side)

-----  
Your choice

## STEP 3

Choose Your Arm & Seat Cushion

-----  
Your choice

Standard Cushions:  
Spring Down seats and  
Blend Down backs

NOTE: Arm choice determines  
overall width (see reverse side)

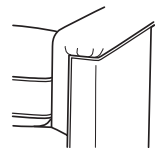

**CF** Cap  
7" wide

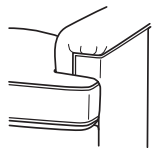

**CT** Cap-T  
7" wide

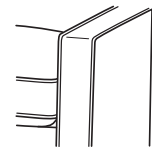

**TF** Track  
5" wide

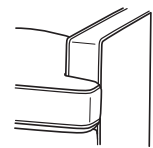

**TT** Track-T  
5" wide

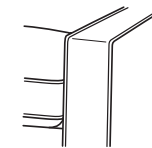

**WF** Wide Track  
8" wide



**WT** Wide Track-T  
8" wide

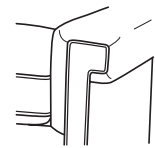

**KF** Key  
8" wide (chair 7")

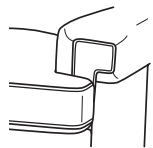

**KT** Key-T  
8" wide (chair 7")

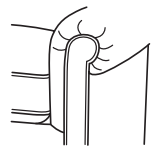

**RF** Rolled  
8" wide (chair 7")



**RT** Rolled-T  
8" wide (chair 7")



**SF** Sock  
8" wide (chair 7")



**ST** Sock-T  
8" wide (chair 7")

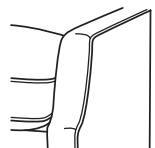

**NF** Notched  
5" wide



**EF** English  
6" wide

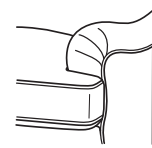

**ET** English-T  
6" wide

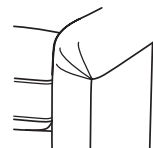

**PF** Pleated  
8" wide (chair 7")



**PT** Pleated-T  
8" wide (chair 7")

## STEP 4

Choose Your Back Cushion

-----  
Your choice



**1** Square Boxed-T

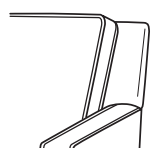

**2** Square Boxed

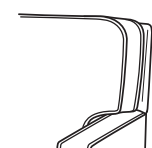

**3** Round Boxed-T

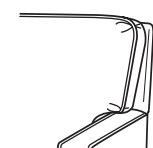

**4** Knife Edge-T

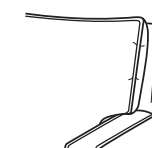

**5** Bed Pillow-T

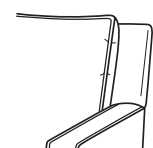

**6** Bed Pillow

## STEP 5

Choose Your Base

-----  
Your choice

Standard Finish: Sussex

NOTE: Sleepers not available  
with base B or H (see reverse  
side)

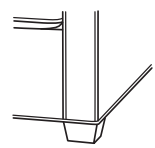

**A** Tapered Leg  
3" high

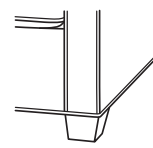

**B** Tall Tapered Leg  
4" high

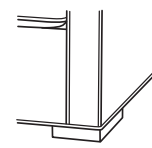

**C** Block Leg  
1.5" high, 6" wide

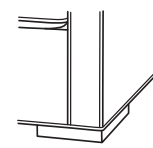

**D** Large Block Leg  
1.5" high, 8" wide

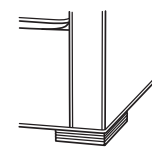

**E** Fluted Leg  
1.5" high, 6" wide

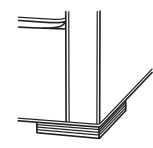

**F** Large Fluted Leg  
1.5" high, 8" wide

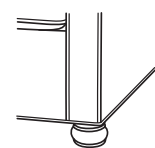

**G** Bun Foot  
3" high

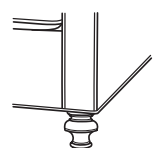

**H** Turned Leg  
5" high

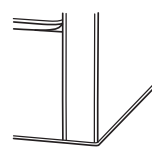

**I** Upholstered Base  
**ISB** Swivel Base

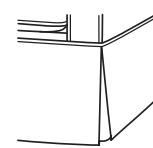

**J** Kick Pleat Skirt  
**JSB** Swivel Base

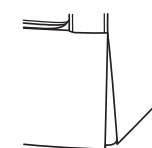

**K** Waterfall Skirt  
**KSB** Swivel Base

## YOUR CUSTOM CHOICES STYLE NUMBER

(Leather) STEP 1 STEP 2 STEP 3 STEP 4 STEP 5

-----  
Your choice

L if ordering leather  
Depth S-38"  
M-41"  
Style No. Sofa, Chair, etc.  
Arm/Seat  
Back  
Base



Sofa shown:

**M02-CT2A** M-Plush Depth 41", **02**-Two Cushion Sofa, **CT**-Cap Arm-T Cushion, **2**-Square Boxed Back, **A**-Tapered Leg  
Complimentary options shown: contrasting fabric on throw pillows and Ash finish



MASSOUDFURNITURE.COM

**STEP 2** Choose Your Style

**S** Standard depth 38" dimensions and 19" pillows shown in **BLACK**  
 Overall d38 h38 Arm h25  
 Inside d21 Seat h19

**M** Plush depth 41" dimensions and extra 19" pillows shown in **GRAY**  
 Overall d41 h38 Arm h25  
 Inside d23 Seat h19

All pillows are 19" x 19"  
 Scale 1/4" = 1"  
 All dimensions are approximate

**FURNITURE STYLES** Drawings are based on an 8" wide track arm and also apply to key, pleated, rolled, and sock arm styles, except the 21 chair which is 2" less. Please deduct from the width of the following arm styles: cap - 1" per arm; English - 2" per arm; notched and track - 3" per arm.

Scale 1/4" = 1"  
 All dimensions are approximate  
 Leather styles have seams applied at factory discretion and do not include throw pillows  
 \*Sleepers not available with B and H bases

**01** Sofa  
**81** Sleeper\*

**02** Sofa  
**82** Sleeper\*

**03** Long Sofa

**04** Short Sofa  
**84** Sleeper\*

**05** Short Sofa  
**85** Sleeper\*

**06** Wedge Sofa

**07** Loveseat

**21** Chair  
 Swivel Available

**22** Chair & 1/2  
**83** Sleeper  
 Swivel Available

**41** Ottoman  
**42** Storage  
 18" high

**43** Ottoman & 1/2  
**44** Storage  
 18" high

**45** Cocktail Ottoman  
 18" high

**31** Chaise

**32** Wide Chaise

**SECTIONAL STYLES** Drawings are based on an 8" wide track arm and also apply to key, pleated, rolled, and sock arms. Please deduct from the width of the following arm styles: cap - 1" per arm; English - 2" per arm; notched and track - 3" per arm.

**71** Left Arm Sofa Return

**72** Right Arm Sofa Return

**51** Left Arm Sofa

**52** Right Arm Sofa

**53** Left Arm Loveseat

**54** Right Arm Loveseat

**55** Left Arm Wedge Loveseat

**56** Right Arm Wedge Loveseat

**57** Left Arm Chair

**58** Right Arm Chair

**59** Left Arm Chaise

**60** Right Arm Chaise

**61** Armless Sofa

**62** Armless Loveseat

**63** Armless Chair

**73** Square Corner

**74** Curved Corner

**OPTIONS**  
 Seam Treatments - Self welt is standard, baseball stitching and edge seam are optional.  
 Nail Trim - Optional nail trim is applied around base and panels of cap, key and rolled arms.  
 See price list for additional options and pricing.

**QUESTIONS?**  
 Please contact us at 800-762-2797  
 or contactus@massoudfurniture.com